

# Caravans 2024



***Dethleffs***  
A friend of the family





# Welcome

to Dethleffs. Travelling is a very pleasant hobby. Together with your family you can discover new regions and find new friends. In short, camping lets you get close to nature. With one of our Dethleffs caravans you can experience this in a very special way. Discover the meaning of caravanning with Dethleffs. Let's go!

In addition to the information in this brochure, we have prepared additional multimedia information for you, such as videos, pictures, product information and prices.



internet



in the technical information



Dethleffs Original Accessories\*



Video available online



a 360 degree "all around view" of many vehicles is available online



configure your new Dethleffs caravan online, free of charge and with no obligation

Stay up to date with us on Social Media:



Please note that the pictures in this brochure may show alternative designs or options that are available at extra cost.

\* Can be ordered separately from the dealer, individual articles are also available in the online shop.

# The invention of the “camper car” – a love story!



As a junior manager in his father's whip and bridle factory, Arist Dethleffs was often away on business trips for weeks on end. He missed his family so much during these times that he promptly invented the “camper car” in 1931 – the first caravan in Germany. This devoted family man thus not only invented, but then also pioneered a completely new form of travel, which remains extremely popular today.

The Dethleffs family and their vehicle/trailer combination aroused curiosity and interest wherever they went. And so Arist soon began returning from his travels with orders for camper cars, which he manufactured in a small garage on the company premises.

The startup quickly picked up speed and left the small garage to become a separate division that focused exclusively on building caravans. Caravanning soon established itself as an entire movement in its own right.



Learn more about caravanning, company milestones, customer stories and other campaigns at: [history.dethleffs.com](https://www.history.dethleffs.com)

# A pioneering spirit that fascinates us to this day



# We do “Quaravanning”.

Actually, at Dethleffs the word “caravanning” should really begin with a “Q” because our vehicles are the perfect manifestation of our quality standards – based on almost a century of experience. We have embodied the pioneering spirit of our founder Arist Dethleffs for 90 years and devote all of our energy to building the best recreational vehicles of their time. We stay true to our values and focus on what really matters:

## Quality is in our DNA

- Optimised manufacturing processes based on the highest quality standards
- Precision and craftsmanship by largely self-trained specialists
- Exclusive use of high-quality components and materials

## Rethinking responsibility

- Skilled specialists in all trades
- In-house training (one of the largest training companies in the region)
- Continuous further training

## Staying ahead through outstanding service

- Reliability and safety thanks to our large service and dealer network
- With more than 350 dealers and service partners throughout Europe, help is always close at hand when needed
- State-of-the-art spare parts warehouse
- 18,500 spare parts permanently available
- 93% of dealer orders are fulfilled within three days
- Regular workshop training ensures that our dealers are up to date with the latest knowledge



Experience the production of our caravans and motorhomes live!



High-quality products, “Made in Germany” at Dethleffs in Isny (Allgäu).

We operate one of Europe’s most advanced production facilities for recreational vehicles

# Quality that inspires



# The Dethleffs Caravan Family

## C'JOY

Compact, easy to handle, with up to seven berths. With everything you need to experience true freedom – specially designed for families.

Page 10



## C'GO & C'GO UP



Modern, fresh and always ready to go. The “to go” caravan with a large selection of layouts.

Page 20



## CAMPER®

Ideal touring companion for families, thanks to a wide range of bunk beds and storage space.

Page 44



## NOMAD

Elegant interior and extensive standard equipment make the Nomad perfect for demanding travellers.

Page 54





## AERO & AERO UP

The traditional classic with an airy, modern AERO look. The AERO up is a compact yet space-saving caravan with a pull-down bed that further expands the Dethleffs model range.

Page 32



## BEDUIN SCANDINAVIA

Stylish looks, designed for every comfort and equipped with numerous extras – your companion for all seasons.

Page 64



Reliability 74

Dethleffs Original Accessories 78

## Want to learn more about Dethleffs?

Then sign up for our newsletter today! Discover details of our new products, travel tips & tricks from professionals as well as all our latest promotions and competitions.



[www.dethleffs.com/newsletter-registration](http://www.dethleffs.com/newsletter-registration)



# Pure happiness C'JOY



## C'JOY Highlights

- + The perfect starter caravan with up to seven berths – ideal for families
- + Never fear the narrow streets: one of the smallest caravans in its class with a width of just 2.12 m
- + A real lightweight: with the appropriate towing vehicle, you only need a standard class B driver's licence
- + Protects you from bad weather: roof, front and rear made of robust GRP
- + No need to compromise – you can bring everything you need thanks to lots of useful storage space



2-part entrance door



The front, roof and rear are made of robust GRP



With plentiful storage space and a large payload, everything you need is already on board



LIVING

# Pure holiday feeling



A hearty breakfast in the cosy seating lounge is a great way to start the day and ensures a successful holiday

Practical: the seating lounge can easily be converted to a sleeping area • 480 QLK | Timor



1 Practical 3-burner hob with manual ignition

2 The cosy single beds offer extreme comfort and, if required, can be interconnected via additional (optional) elements to form a large sleeping area

3 Additional sleeping berths can be created by converting the seating lounge

SLEEPING

# On holiday at last!



Bonne nuit: enjoy restful sleep in a comfortable queen bed · 480 QLK | Timor



Up to three sleeping berths are optionally available in the bunk bed in the rear of the c'joy · 480 QLK | Timor

BATHROOM

# Refreshment



The c'joy is equipped with an attractive sink - 480 QLK | Timor



In the c'joy you don't need to make do without a bathroom - you will find everything you need for a refreshing start to the day - 460 LE | Timor

COOKING

# Small kitchen, big potential



Compact and practical: with 3-burner hob, stainless steel sink and abundant storage space  
• 480 QLK | Timor



Many models include a large 131.5-litre compressor fridge with a 15-litre freezer • 480 QLK | Timor



# c'JOY Highlights



You can find the full specification for the c'JOY models in the separate technical information or at [www.dethleffs.com/cjoy](http://www.dethleffs.com/cjoy)



Sustainable fabrics made from 100% recycled PET bottles



c'joy goes digital! The innovative SIU system (option) sends important vehicle information to your mobile phone! For detailed information see page 79



2-person bunk bed, optionally also available with a 3-person bunk bed (depending on layout)

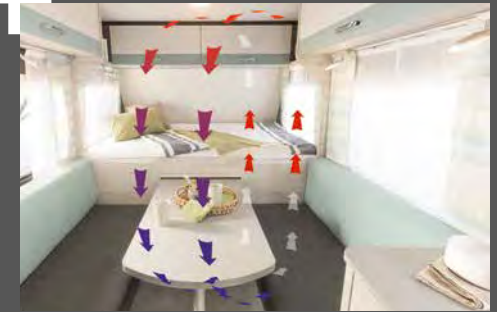

AirPlus – perfect air circulation in the interior with rear ventilation of the overhead lockers and sideboards



Compressor fridge as standard



Cold foam mattresses as standard on all fixed single and double beds



With a width of just 2.12 m, the c'joy fits through the narrowest passages



Openable and insulated double-glazed windows with blackout and mosquito blinds

# Variety of choice



Sustainable fabrics made from 100% recycled PET bottles.



Timor



Kapan



Tindari Bora



Further information is provided at:  
[www.dethleffs.com/cjoy](http://www.dethleffs.com/cjoy) or in the  
separate technical information



Ruffled sides, White (standard)

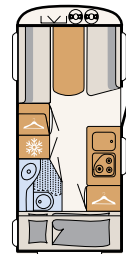

410 LK  
5 sleeping berths

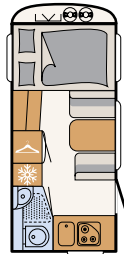

420 QSH  
3 sleeping berths

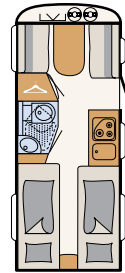

460 LE  
3 sleeping berths

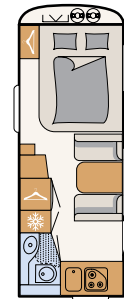

480 FSH  
3 sleeping berths

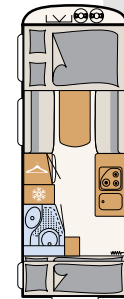

480 QLK  
7 sleeping berths

Compact and affordable with space for up to **seven people!**

The maximum number of berths is achieved with the converted seating lounge, the three-bunk-beds option as well as some additional options.

New model for  
**2024**

# Caravans to go **C'GO & C'GO UP**



## C'GO & C'GO UP Highlights

- + Something for everyone: there is a wide range of layouts for small and big families
- + Stylish living – the new interior embodies current design trends and is characterised by light surfaces, striking contrasts and a straightforward design language
- + Protects you from bad weather: roof, front and rear made of robust GRP
- + Lightweight: it can be towed with a Class B driver's licence (depending on the towing vehicle)
- + c'go up: with a comfortable 200 x 144 cm pull-down bed above the rear seating group as standard

**Openable** and insulated double-glazed windows (grey graphite) with blackout and mosquito blinds



**Accessible from the outside:** large storage space flap with folding bunk bed (optional)



**Premium** brand tyres engineered for 100-kph approval



LIVING

# Cosiness without compromises



Colourful well-being is no problem in this seating lounge  
• 495 QSK | Estepona

Totally flexible: comfortable get-togethers or additional sleeping berths? The seating lounge can be converted in a flash  
• 495 QSK | Estepona



495 FR | Ronda

**1** A large, U-shaped seating lounge and plenty of storage space – and all available in three different upholstery styles

**2** Open washing area with attractive sink

**3** Plenty of space as standard in the 137-litre fridge including 15-litre freezer (depending on layout)

SLEEPING

# Relax and enjoy the view

Many windows for a perfect view are included in every c'go layout. The front bed area can be equipped with a large window or a cosy corner with no window.



Your c'go is available in four different bunk bed layouts. And if that is not enough, you can even opt for three bunk beds · 495 QSK | Estepona





Comfortable bathroom thanks to the open washing area with large mirror • 495 FR | Ronda



All cleaned up in no time! There is always time for a shower in the c'go: an optional shower is available for all layouts

COOKING

# Cooking for every family member



All the kitchen you need: spacious overhead lockers and roomy drawers with soft-close system for plentiful storage space • 495 FR | Ronda



The covers on the sink and cooker serve as a work surface when closed. • 495 FR |



Most c'go models include a large 137-litre fridge/freezer combination with a 15-litre freezer. The cooker has three burners with electric ignition. • 495 FR | Ronda

# C'GO & C'GO UP Highlights



You can find the full specification for the C'GO & C'GO UP models in the separate technical information or at [www.dethleffs.com/cgo](http://www.dethleffs.com/cgo)



Practical 3-burner hob with electrical ignition



The special slatted frames can be configured for optimal use of the available storage space



c'go goes digital! The innovative SIU system (option) sends important vehicle information to your mobile phone! For detailed information see page 79



Safety as standard: AKS stabilizing coupling



Practical chest of drawers in the entrance area (depending on layout)



Cold foam mattresses as standard on all fixed single and double beds



Gas bottle locker for 2 x 11 kg bottles with base made of rot-proof, sturdy aluminium chequer plate



Power-saving LED awning light

C'GO UP

# The family-friendly caravan with a pull-down bed

208 cm interior headroom **UP!**



Bedtime? Simply lower the pull-down bed when it's time to get some rest. At 200 x 140 cm, it offers a pleasantly large sleeping area and is extremely comfortable thanks to the high-quality cold foam mattress and wooden slatted bed frame. • 525 KR | Estepona



The comfortable pull-down bed is stowed under the roof during the day to save space and only appears when actually needed. • 525 KR | Estepona

up!



There are cosy bunk beds for smaller campers • 525 KR | Estepona

Bad weather? Then just let the kids play happily in their own children's area  
• 525 KR | Estepona



Room  
for up  
to 7 people

up!

# Variety of choice

---



Estepona



Ronda



Manilva



WEB Alaska White



Further information is provided at:  
[www.dethleffs.com/cgo](http://www.dethleffs.com/cgo) or in the  
separate technical information



Riffled sides, White (standard)

c'go up, riffled sides, White (standard)

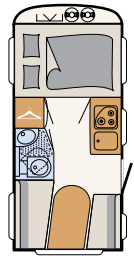

415 QL  
3 sleeping berths

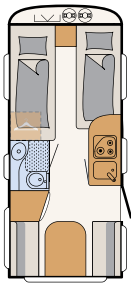

475 EL  
3 sleeping berths

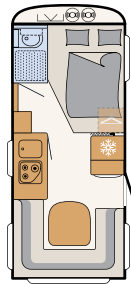

475 FR  
4 sleeping berths

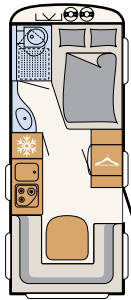

495 FR  
4 sleeping berths

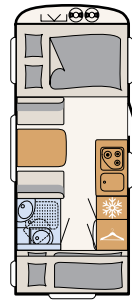

495 QSK  
6 sleeping berths



565 FMK  
6 sleeping berths

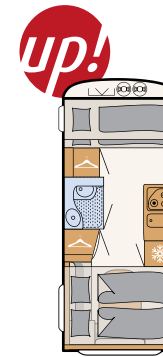

465 KR  
6 sleeping berths

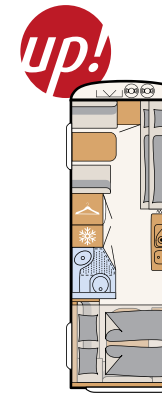

525 KR  
7 sleeping berths

The maximum number of berths is achieved with the converted seating lounge, the three-bunk-beds option as well as some additional options.

Love is in the air

# AERO & AERO UP





## AERO & AERO UP Highlights

- + The compact yet incredibly spacious Aero up offers maximum space and flexibility
- + Eye-catching design: the modern exterior will attract plenty of attention and the interior is packed with convincing details
- + Winter is coming: perfectly equipped for colder temperatures thanks to optional Winter Comfort Package
- + Protects you from bad weather: roof, front and rear made of robust GRP
- + AERO up – with a comfortable 200 x 144 cm pull-down bed above the rear seating group as standard



**Extra-wide** entrance door with window and fly screen



**Designer add-on elements** for front and rear



**17-inch alloy wheels** in Dethleffs design underline the vehicle's stylish appearance (optional)



LIVING

# Light, bright design that inspires



The place to be: the Dethleffs Aero's generous sense of space is best experienced in the spacious seating lounge • 510 ER | Skagen



Light, airy and comfortable for pure camping fun • 490 QSK | Fyn



510 ER | Skagen

1 Elegant and functional textile elements for stowing and fastening

2 3-burner hob with electrical ignition and sturdy cast iron grate

3 Airy, Scandinavian design in proven Dethleffs quality. The Aero is available in three modern, fresh upholstery styles: Fyn, Skagen and Visby

SLEEPING

# Sleeping on air



The single beds can optionally be converted into a large sleeping area in the blink of an eye (option)  
• 510 ER | Skagen



Sweet dreams! Ideal for smaller campers – cosy bunk beds with a view • 490 QSK | Fyn

BATHROOM

# Freshen up for the day ahead

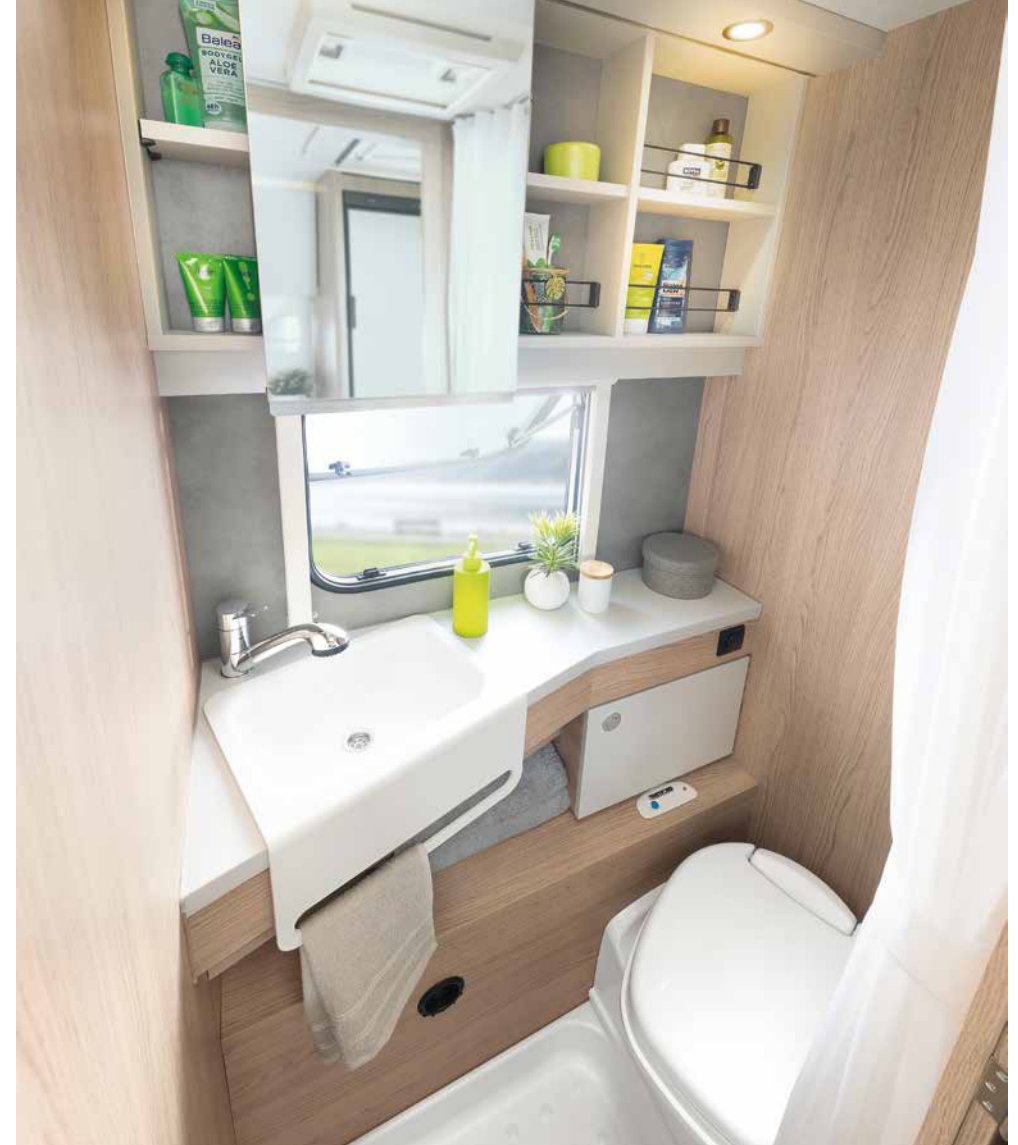

Compact bathroom in light colours with beautiful, practical details, such as the integrated towel rail - 510 ER | Skagen

The practical shelves and mirror cabinet offer plenty of storage options - 510 ER | Visby

COOKING

# Cooking made easy



Bright and spacious: the kitchen with 137-litre fridge including 15-litre freezer (depending on the layout) • 500 QSK | Visby



The hot-water system is included in the Touring Package

AERO UP

# Aero up – airy design with extreme flexibility

198 cm interior headroom **UP!**



Despite its compact dimensions, the Aero up offers maximum space and flexibility • 530 ER | Skagen

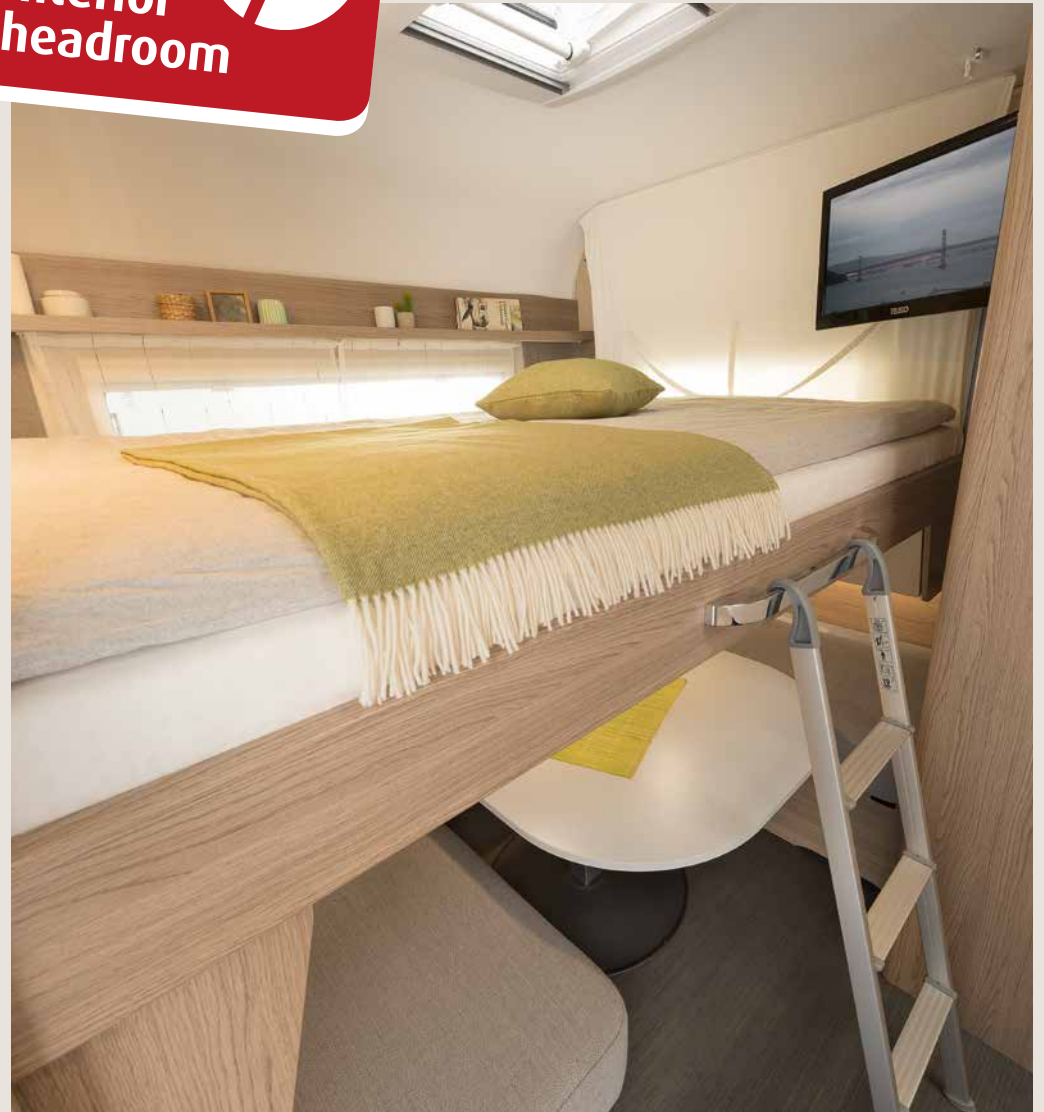

Travel as a couple or with friends in total comfort thanks to the practical pull-down bed above the seating lounge • 530 ER | Skagen



Simply push up the pull-down bed and let the fun begin! The seating lounge offers ample space for all kinds of holiday fun • 530 ER | Skagen



Sanctuary – a play space can be created here in no time at all • 530 KR | Fyn



# AERO & AERO UP Highlights



You can find a full overview of the ready to go equipment at [www.dethleffs.com/aero](http://www.dethleffs.com/aero)



Large 137-litre fridge with 15-litre freezer (depending on layout)



Aero goes digital! The innovative SIU system (option) sends important vehicle information to your mobile phone! For detailed information see page 79



The large panoramic skylight with LED light lets both air and daylight into the vehicle (optional)



AirPlus – perfect air circulation in the interior with rear ventilation of the overhead lockers and sideboards



Flexible click spotlights and USB socket



Atmospheric light and ambiance thanks to indirect lighting (option)



Crank insertion aid for convenient operation of the crank supports

# Variety of choice



Visby



Skagen



Fyn



Maryland Oak



Further information is provided at:  
[www.dethleffs.com/aero](http://www.dethleffs.com/aero) or in the  
separate technical information



Smooth sides, White

Smooth sides, White

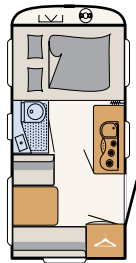

410 QS

3 sleeping berths

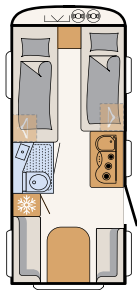

470 EL

3 sleeping berths

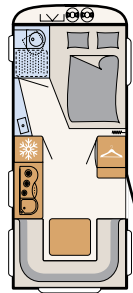

470 FR

4 sleeping berths

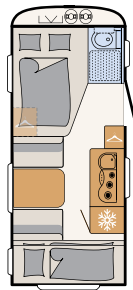

470 FSK

6 sleeping berths

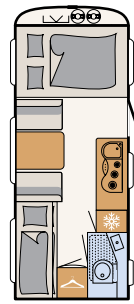

490 QSK

6 sleeping berths

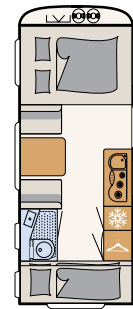

500 QSK

6 sleeping berths

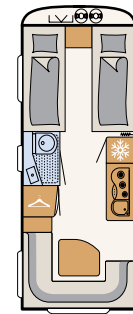

510 ER

4 sleeping berths



520 ER

4 sleeping berths

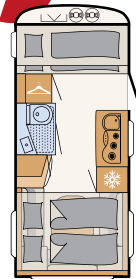

460 KR

4 sleeping berths

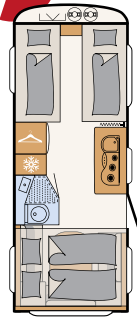

530 ER

4 sleeping berths

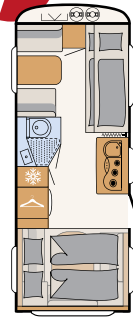

530 KR

5 sleeping berths

The indicated number of sleeping berths are maximum values and are partly only available with optional fittings.

# Fresh ideas for family caravans **CAMPER**<sup>®</sup>



## CAMPER® Highlights

- + Enough space for every child: a selection of family layouts with bunk beds
- + Ready to go thanks to a comprehensive standard specification
- + Better safe than sorry: exemplary Dethleffs safety equipment
- + Stylish exterior design: design rear moulding with LED light for a stylish appearance
- + Designed to suit all needs: even short caravans under 7 m long are available



**17-inch alloy wheels** in Dethleffs design underline the vehicle's stylish appearance (optional)



**Standard storage compartment flap** provides easy access to additional storage space (depending on the layout)

**Large "rear garage"** thanks to folding bunk bed (depending on layout)



LIVING

# Pure holiday feeling



Friendly interior design with light wood characterises our “friend of the family” • 560 FMK | Cloud



Generous space in the U-shaped seating lounge ensures an all-round feeling of well-being for holidaymakers young and old • 730 FKR | Galaxy



**1** We are a friend of the family! The Camper® ranges offer a wide selection of bunk bed layouts. A third bunk bed is optionally available in most models

**2** Practical and easy to reach: the moveable click spotlights and a USB socket for charging

**3** Kitchen with plentiful storage space thanks to the practical apothecary-style drawer for bottles and numerous storage compartments

SLEEPING

# A friend of the family



The comfortable single beds can be converted into a huge double bed, if desired (option). Dethleffs mattress topper with matching fitted sheet. Available with Dethleffs Original Accessories (see p. 78)

The large French bed in the entrance area offers plenty of space to relax • 500 QSK | Galaxy

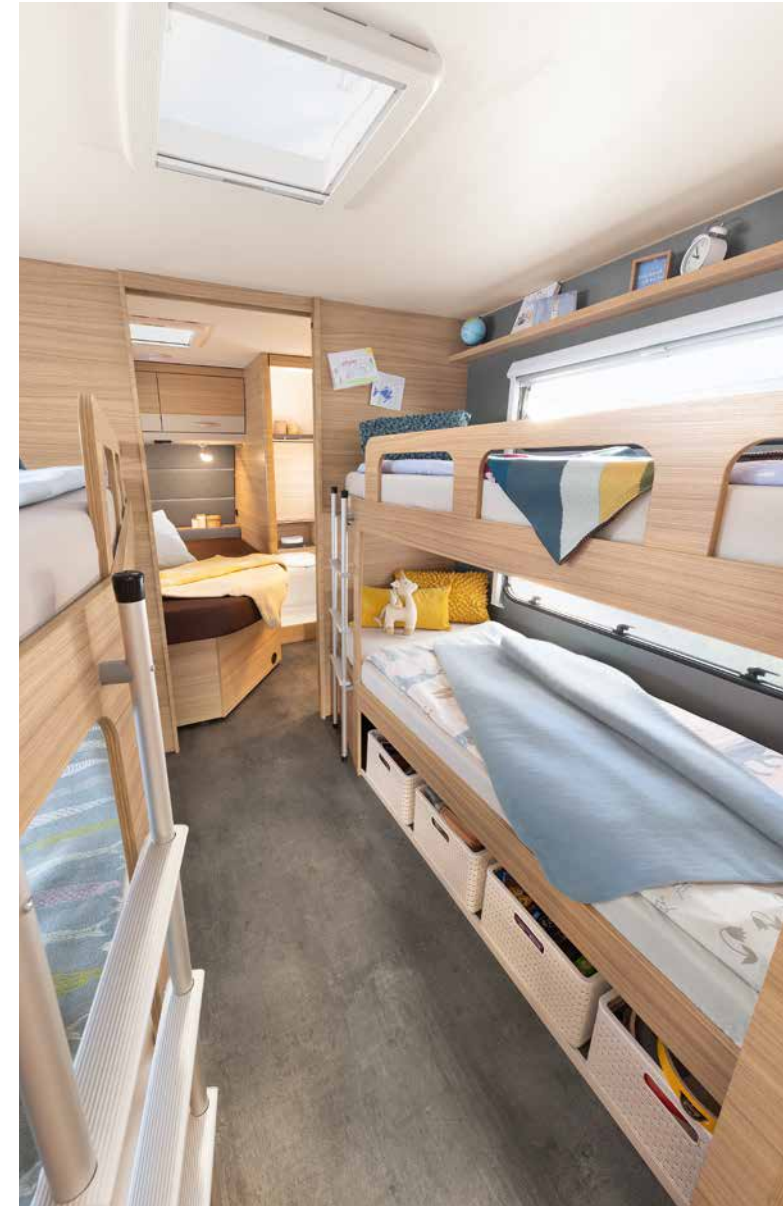

Perfect for large families: a second bunk bed for two people is optionally available instead of the seating lounge (depending on the layout) • 730 FKR | Galaxy



BATHROOM

# Wellness Oasis

With its compact bathroom, the Camper® includes everything you need to freshen up for your holiday • 550 ESK | Mount

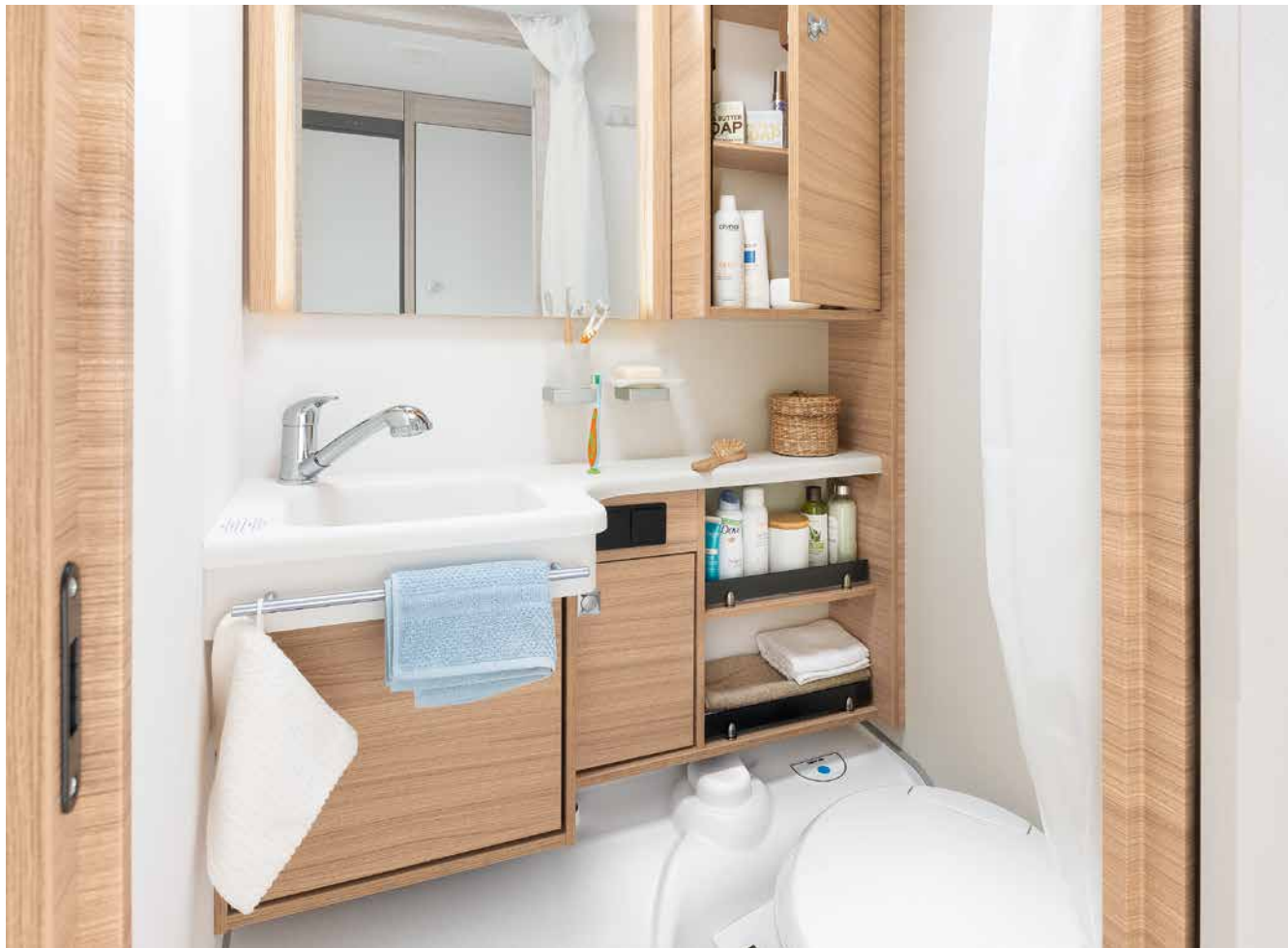

Next to the large bed is the spa area: a shower room with toilet  
• 730 FKR | Galaxy

COOKING

# Holiday kitchen made easy



In the spacious drawers and overhead lockers there is room for everything you need in your holiday kitchen • 730 FKR | Galaxy



Practical kitchen with large drawers and apothecary-style drawer • 550 ESK | Mount

# CAMPER® Highlights



You can find the full specification for the CAMPER® models in the separate technical information or at [www.dethleffs.com/camper](http://www.dethleffs.com/camper)



Large 137-litre fridge with 15-litre freezer (depending on layout)



A second two-person bunk bed is optionally available instead of the seating lounge in the 730 FKR



Robust GRP roof protects against hail and branches

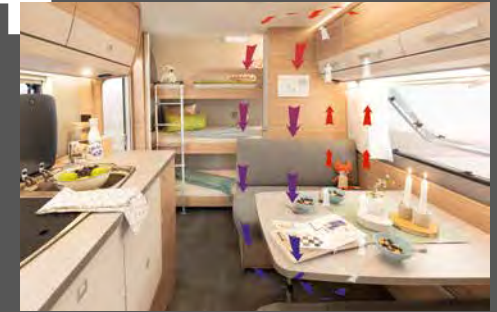

AirPlus – perfect air circulation in the interior with rear ventilation of the overhead lockers and sideboards



Perfect sleeping comfort thanks to the SleepWell system



Modern rear light moulding with LED lights



Hot water system included as standard

# Variety of choice

---



Cloud

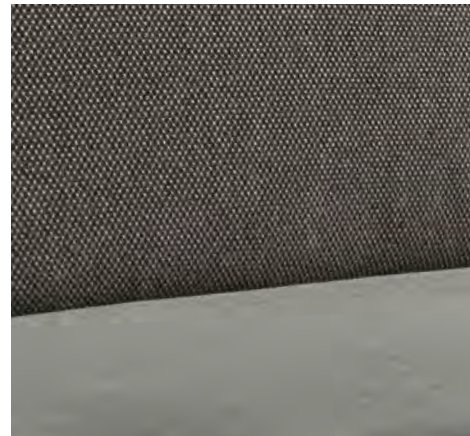

Galaxy



Mount



Rosario Cherry



Additional information can be found at:  
[www.dethleffs.com/camper](http://www.dethleffs.com/camper) or in the  
separate technical information



Riffled sides, White (standard)

Smooth sides, White

Smooth sides, Silver-Metallic

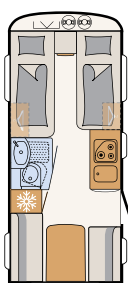

460 EL  
3 sleeping berths

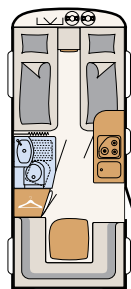

470 ER  
3 sleeping berths

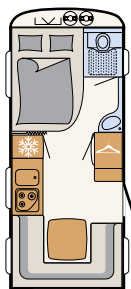

470 FR  
4 sleeping berths

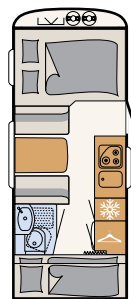

500 QSK  
6 sleeping berths

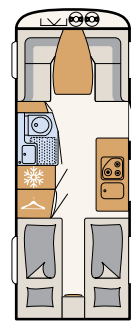

510 LE  
4 sleeping berths

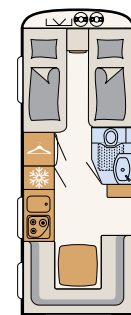

510 ER  
4 sleeping berths

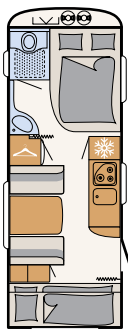

530 FSK  
6 sleeping berths

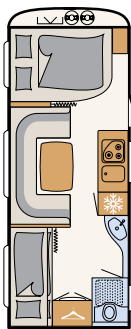

540 QMK  
6 sleeping berths

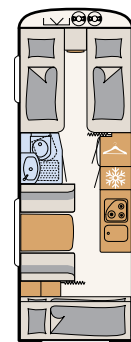

550 ESK  
6 sleeping berths

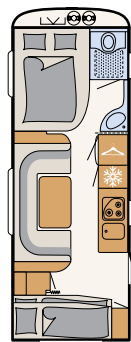

560 FMK  
6 sleeping berths

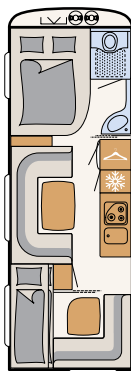

650 FMK  
6 sleeping berths

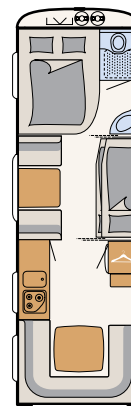

730 FKR  
8 sleeping berths

The maximum number of berths is achieved with the converted seating lounge, the three-bunk-beds option as well as some additional options.

# Experience pays off **NOMAD**



## NOMAD Highlights

- + Something for everyone: wide range of touring caravans with double or single beds
- + Sophisticated exterior design with chic details such as the design rear moulding with LED lights and chrome manoeuvring handles
- + Feel-good atmosphere: exquisite, elegant living room design with atmospheric lighting concept
- + Cooking like at home: superbly equipped gourmet kitchen with illuminated kitchen rear panel
- + Ready to go thanks to a comprehensive standard specification

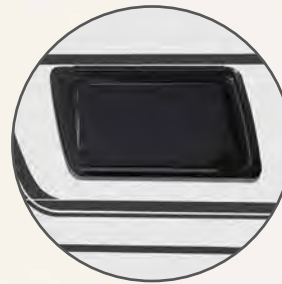

**Flush-fitting windows** provide good insulation and security (option)

**Standard storage compartment flap** provides easy access to additional storage space (depending on the layout)



**Design rear moulding** with LED lights as well as manoeuvring handles in chrome finish



LIVING

# Comfortable Nomad life



A sturdy wooden sliding door separates the children's and parents' bedrooms from each other and from the living room  
• 730 FKR | Chromo



A generous kitchen that spans the entire width of the vehicle, as well as the adjoining seating lounge, ensure perfect living comfort • 490 BLF | Ruby





1 Perfect for sitting together comfortably, and also for a relaxing sleep - the large U-shaped seating lounge in the front

2 Gourmet kitchen with illuminated kitchen rear panel

3 The large panoramic skylight with LED light lets both air and daylight into the vehicle

SLEEPING

# First class sleeping comfort



Two wide single beds ensure restful sleep and can be easily converted into a double bed · 460 EL | Chromo



The large double bed is easily accessible from three sides and can be pushed back during the day to create even more space · 650 RQT | Chromo

BATHROOM

# Spacious bathroom



Freshen up for the day ahead. In the bathroom you will find everything you need - 490 BLF | Champion



The open bathroom provides a lot of headroom - 490 EST | Ruby

## COOKING

# Large kitchen for those who appreciate “more”



Fresh ingredients can be stored in the large 137-litre fridge, which features a spacious door compartment that can accommodate wine bottles and water bottles (up to 1.5 litres). Indirect lighting below the kitchen worktop ensures a good view of the spacious drawers. Additional comfort feature: the standard hot water system

• 490 BLF | Ruby



Spacious kitchen with practical pharmacy-style drawer, space for a coffee machine, as well as a 3-burner hob with electric ignition and illuminated kitchen rear panel • 520 ELT | Ruby



# NOMAD Highlights



You can find the full specification for the NOMAD models in the separate technical information or at [www.dethleffs.com/nomad](http://www.dethleffs.com/nomad)



High-quality 3-burner gas hob with electric ignition



Designer overhead locker door – with clever handles for quick and easy opening



Flexible click spotlights and USB socket



AirPlus – perfect air circulation in the interior with rear ventilation of the overhead lockers and sideboards



Generous legroom is ensured thanks to the height-adjustable, single-column telescopic table



Perfect sleeping comfort thanks to seven-zone mattresses made of climate-regulating material



Making space: the clever rail system for small kitchen utensils is included as standard (depending on layout)



Powerful warm-air heating as standard (depending on layout)

# Variety of choice

---



Ruby



Champion



Chromo



Noce Nagano



Further information is provided at:  
[www.dethleffs.com/nomad](http://www.dethleffs.com/nomad) or in the  
separate technical information



Riffled sides, White (standard)

Smooth sides, White

Smooth sides, Silver-Metallic

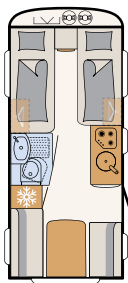

460 EL  
3 sleeping berths

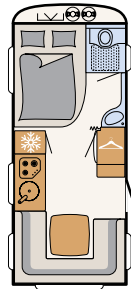

470 FR  
4 sleeping berths

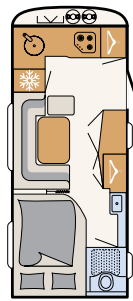

490 BLF  
3 sleeping berths

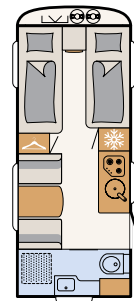

490 EST  
3 sleeping berths

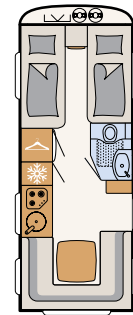

510 ER  
4 sleeping berths

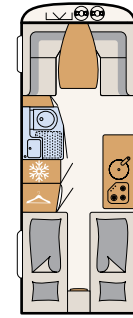

510 LE  
4 sleeping berths

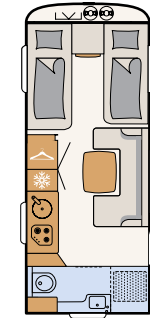

520 ELT  
3 sleeping berths

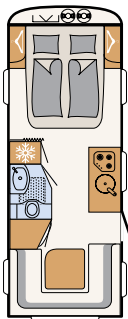

530 DR  
4 sleeping berths

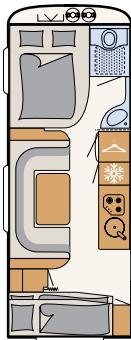

560 FMK  
6 sleeping berths



560 RET  
4 sleeping berths

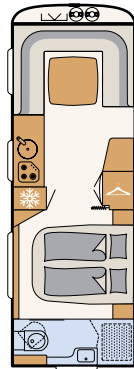

650 RQT  
4 sleeping berths

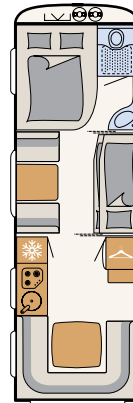

730 FKR  
8 sleeping berths

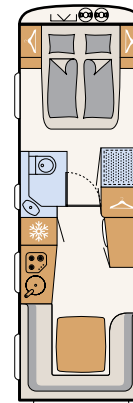

760 DR  
4 sleeping berths

The maximum number of berths is achieved with the converted seating lounge, the three-bunk-beds option as well as some additional options.



Your winter expert  
**BEDUIN**  
**SCANDINAVIA**



## BEDUIN SCANDINAVIA Highlights

- + Welcome aboard: the legendary model from 1956, created by the inventor of the caravan, returns to the road
- + Scandinavian design jewel with loft ambience: overhead lockers finished with real wood – handles and decorative elements in a natural felt look
- + Superbly equipped kitchen as standard: the full cooker is both a stove and oven in one
- + Perfect warmth even at sub-zero temperatures: the standard premium warm-water heating and electric floor heating provide pleasant warmth throughout the caravan
- + Perfectly equipped: the Beduin Scandinavia offers a 5-star camping experience in both summer and winter



**Well insulated** for the winter, thanks to the Dethleffs flush fitting windows (option)



**All aboard:** 70 cm habitation door with internal hinges, window and fly screen as standard

**Exterior design** with smooth sides; white ex works



LIVING

# Travel in a stylish caravan



Charming design: the stylish sideboard is included as standard in the Beduin Scandinavia (optional 32" TV with TV lift available) • 550 SE | Amposta

Stylish upholstery and indirect lighting create a particularly cosy atmosphere • 550 SE | Amposta



1 Equipped for any weather: large wardrobe for jackets and co.

2 The generous U-shaped seating lounge with its high-quality upholstery invites you to relax

3 The overhead lockers are equipped with elegant real-wood handles

SLEEPING

# First class sleeping comfort



The spacious queen bed in the Beduin Scandinavia offers plenty of room for two • 690 BQT | Tarragona



The comfortable single beds promise a restful night's sleep. The generous adjoining bathroom stretches across the full width of the vehicle • 670 BET | Tarragona

BATHROOM

# Spacious bathroom

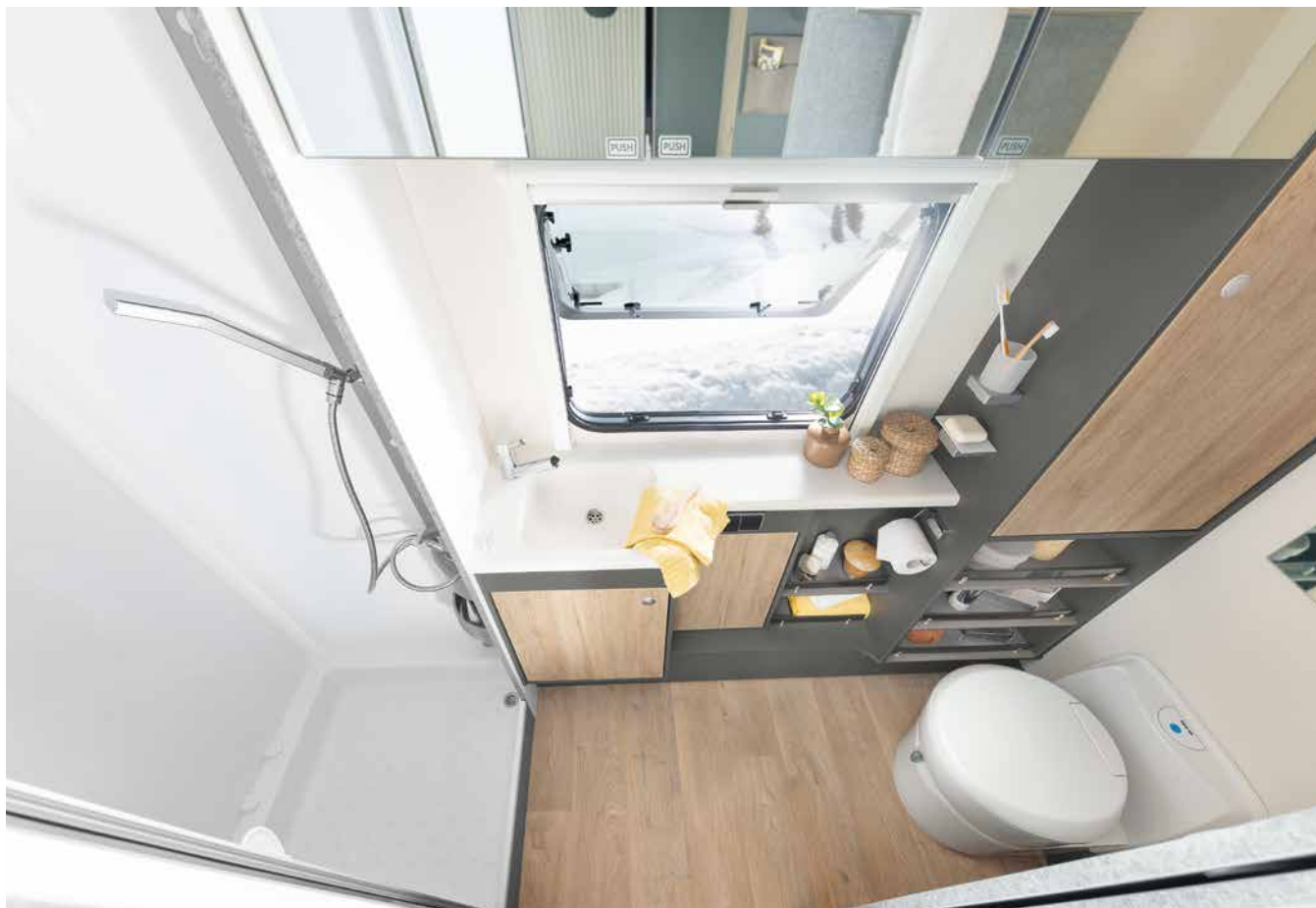

The bathroom, which stretches across the entire width of the vehicle with an integrated shower, is the perfect place to start your day • 690 BQT | Tarragona



Taking a shower? The fold away sink disappears into the wall to save space • 740 BFK | Badalona

COOKING

# Star kitchen for gourmets

All the kitchen you need: apothecary-style drawer, 156-litre fridge including 29-litre freezer with room for everything a foodie's heart could desire • 740 BFK | Amposta



A quick trip to the market. And then cook like a pro chef in the superbly equipped kitchen - with illuminated back wall and full cooker • 650 RE | Amposta



# Beduin Scandinavia Highlights



You can find the full specification for the BEDUIN SCANDINAVIA models in the separate technical information or at [www.dethleffs.com/beduin-scandinavia](http://www.dethleffs.com/beduin-scandinavia)



Large fridge/freezer combination: 137 litres with 15-litre freezer or 156 litres with 29-litre freezer (depending on layout)



Light-flooded front kitchen that stretches across the entire width of the vehicle with full-cooker and large panoramic front skylight (depending on layout)



Seating lounge with sturdy, height-adjustable table (one-hand operation) and high-quality upholstery with corner headrests as standard



AirPlus – perfect air circulation in the interior with rear ventilation of the overhead lockers and sideboards



Spacious rear bathroom across the entire width of the vehicle with plenty of elbow room (depending on layout)

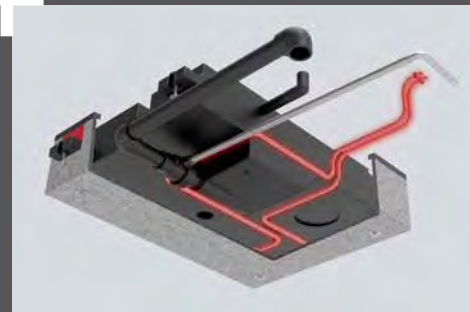

Heated and insulated 42-litre waste-water tank so that nothing freezes – even when the temperature falls below zero (option)



Hot-water heating and electric floor heating as standard

# Variety of choice

---



Amposta



Badalona



Tarragona



Amberes Oak



Further information is provided at:  
[www.dethleffs.com/beduin-scandinavia](http://www.dethleffs.com/beduin-scandinavia)  
or in the separate technical information





Smooth sides, White (standard)

Smooth sides, Silver-Metallic

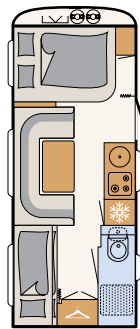

540 QMK

5 sleeping berths

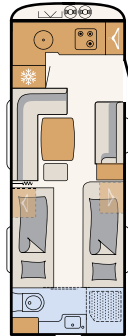

550 BET

3 sleeping berths

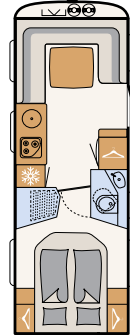

550 RD

3 sleeping berths

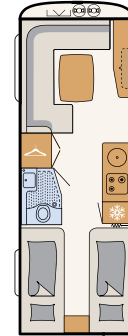

550 SE

3 sleeping berths

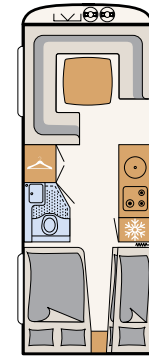

590 RK

6 sleeping berths

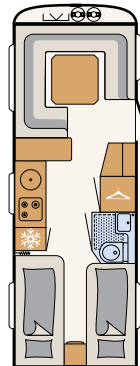

650 RE

4 sleeping berths

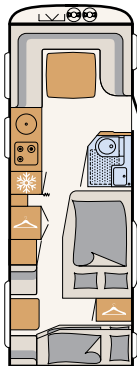

650 RFK

7 sleeping berths

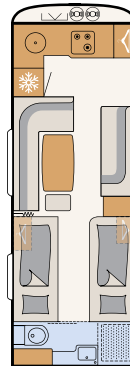

670 BET

3 sleeping berths



690 BQT

3 sleeping berths

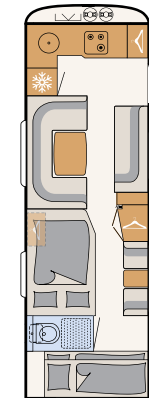

740 BFK

6 sleeping berths

The maximum number of berths is achieved with the converted seating lounge, the three-bunk-beds option as well as some additional options.

A photograph of two men in a professional setting. The man on the left is seen from the back, wearing a dark blue suit jacket and glasses. The man on the right is facing him, smiling broadly, wearing a light blue button-down shirt and holding a green clipboard with papers and a pen. They are shaking hands. The background is a blurred industrial or office environment.

Our promise:

**Reliability,  
Comfort &  
Service**



# Bon voyage!

No matter which Dethleffs is right for you, all our vehicles focus on two things – ensuring your safety and comfort on the road, and that you will enjoy your travel companion for many years to come.

Which is why, for many years, we have made sure that you are always comfortable and safe during your travels with innovative ideas such as our proprietary SleepWell system, Airplus ventilation, Winter Comfort Packages and other clever components.

Our original accessories range also includes high-quality spare parts and clever accessories for caravanners.

So start your next travel adventure with us – we look forward to welcoming you to the Dethleffs family. And if you ever need help, our comprehensive dealer and service network is standing by to provide fast and straightforward assistance.

RELIABILITY

# With every weather condition

The Allgäu is home to the hardest winters – and since 1931, also to us! As we still have real winters, we mostly know what is especially needed for winter camping. All Dethleffs caravans are suitable for winter use as standard. With our ingenious Winter Comfort Packages your caravan becomes winterproof and can easily master very harsh conditions like ice and snow. This winterproof equipment ensures the bitter, cold nights are cosily warm inside your caravan.



Stay safe throughout the cold season with a winterproof caravan equipped with the Winter Comfort Package from Dethleffs



A holiday home parked right next to the ski slopes, with a warm and cosy interior just like home

**Suitable for winter use:** at an outside temperature of 0°C, the vehicle's interior can be permanently heated to 20°C.

**Winterproof:** it must be possible to heat a completely cold vehicle from -15°C to +20°C in just four hours.



Detailed information about our winterised caravans can be found at: [www.dethleffs.com/the-winter-specialists](http://www.dethleffs.com/the-winter-specialists)

Your safety is of utmost importance to us and that is why we use reliable, branded vehicle components, trusted for many years. All our caravans are also designed for speeds of up to 100 km/h / 62 mph. And the optional Dethleffs Safety Package takes your safety up another gear – thanks to a stabilising system, crash sensor and smoke detector.



Stay safe on the road thanks to Dethleffs safety equipment and regular driver training courses



The Dethleffs Safety Package is available as an optional extension and offers maximum safety.

# All possible comfort

Wherever warm air cools quickly, moisture is generated – in a caravan, this primarily occurs on the exterior walls during very cold weather. The AirPlus system provides rear ventilation for the overhead lockers, which helps the air to circulate inside the caravan and prevents condensation from the outset. The result is healthy room air without mildew formation or mould spots.

Your home on wheels needs to provide the same comfort level as your home. Restful nights are guaranteed thanks to the Dethleffs SleepWell system.



AirPlus ventilates the overhead lockers and thus prevents the formation of condensation



With flexible slat frames and ergonomic 7-zone mattresses you will sleep like on air



Online you will find more information about the Dethleffs SleepWell system.  
Simply visit: [www.dethleffs.com](http://www.dethleffs.com)

# It's all on board. Dethleffs Original Accessories



Everything in its proper place! With the retrofittable Dethleffs multifunctional rail, you can now enjoy all the advantages of the clever organisation system from Dethleffs – even if the rail is not fitted as standard in your vehicle!



The Dethleffs caravan cellar provides plenty of additional storage space underneath the caravan. Thanks to its practical storage options, you always have an additional, waterproof, practical place for everything you need when camping. Use the spacious bag with the practical double zip under your vehicle as a cool and hygienic storage space for food, drinks, children's toys or other essential items such as shoes and boots.

## SERVICE

Maximum comfort and safety – these are the right ingredients to make you feel completely at home in your mobile home. We therefore offer a range of original accessories for your vehicle, all of which fit perfectly and are ideal enhancements – from cuddly accessories to protective devices and ways to perfectly organise your caravan.

From dashboard insulation to decorative trim, we make your caravanning experience unique and comfortable. You can easily order matching accessories from your dealer and have them retrofitted if necessary. Some items can also be ordered online and delivered directly to your home.

At [www.dethleffs-original-zubehoer.com/en](http://www.dethleffs-original-zubehoer.com/en) you will also find our online shop with exciting offers and promotions.



Additional storage space under the caravan – thanks to waterproof storage bags that are retracted inside the ground apron by means of special piping



The new Dethleffs System Information Unit (SIU) is a digital information centre for your caravan. It lets you display important vehicle information directly on your mobile phone (requires installation of the Dethleffs E-Connect app). Detailed information about the SIU, the E-Connect app and the available sensors can be found at [www.dethleffs-original-zubehoer.com/en](http://www.dethleffs-original-zubehoer.com/en)



Everything else you need on holiday is available thanks to Dethleffs Original Accessories, which are tailored to your vehicle. Simply browse our catalogue at your Dethleffs dealer or online at [www.dethleffs-original-zubehoer.com/en](http://www.dethleffs-original-zubehoer.com/en) or order individual items directly from our new online shop at [www.shop.dethleffs.de](http://www.shop.dethleffs.de)





**Technical changes and errors excepted.** The illustrations of this catalogue partly show decorative elements which are not included in the scope of delivery, or alternative designs or options for which additional costs are incurred. For details on technology, equipment and prices, please refer to the price list.

**Thank you for your support in decorating the vehicles:**

LUSINI Group | [lusini.com](http://lusini.com)  
Eagle Products Textil GmbH

**Photography:** Karl Holzhauser • Rohwein MediaServices •  
eye5.li • Daniel Zangerl • Adobe Stock •  
Forster & Martin Fotografie GbR



Dethleffs GmbH & Co. KG  
Arist-Dethleffs-Straße 12 | D-88316 Isny  
Tel. +49 7562 987-881 | [www.dethleffs.com](http://www.dethleffs.com)

***Dethleffs***  
A friend of the family