



Your winter expert  
**BEDUIN**  
**SCANDINAVIA**

## BEDUIN SCANDINAVIA Highlights

- + Welcome aboard: the legendary model from 1956, created by the inventor of the caravan, returns to the road
- + Scandinavian design jewel with loft ambience: overhead lockers finished with real wood – handles and decorative elements in a natural felt look
- + Superbly equipped kitchen as standard: the full cooker is both a stove and oven in one
- + Perfect warmth even at sub-zero temperatures: the standard premium warm-water heating and electric floor heating provide pleasant warmth throughout the caravan
- + Perfectly equipped: the Beduin Scandinavia offers a 5-star camping experience in both summer and winter



**Well insulated** for the winter, thanks to the Dethleffs flush fitting windows (option)



**All aboard:** 70 cm habitation door with internal hinges, window and fly screen as standard

**Exterior design** with smooth sides; white ex works



LIVING

# Travel in a stylish caravan



Charming design: the stylish sideboard is included as standard in the Beduin Scandinavia (optional 32" TV with TV lift available) • 550 SE | Amposta

Stylish upholstery and indirect lighting create a particularly cosy atmosphere • 550 SE | Amposta



1 Equipped for any weather: large wardrobe for jackets and co.

2 The generous U-shaped seating lounge with its high-quality upholstery invites you to relax

3 The overhead lockers are equipped with elegant real-wood handles

SLEEPING

# First class sleeping comfort



The spacious queen bed in the Beduin Scandinavia offers plenty of room for two • 690 BQT | Tarragona



The comfortable single beds promise a restful night's sleep. The generous adjoining bathroom stretches across the full width of the vehicle • 670 BET | Tarragona

## BATHROOM

# Spacious bathroom

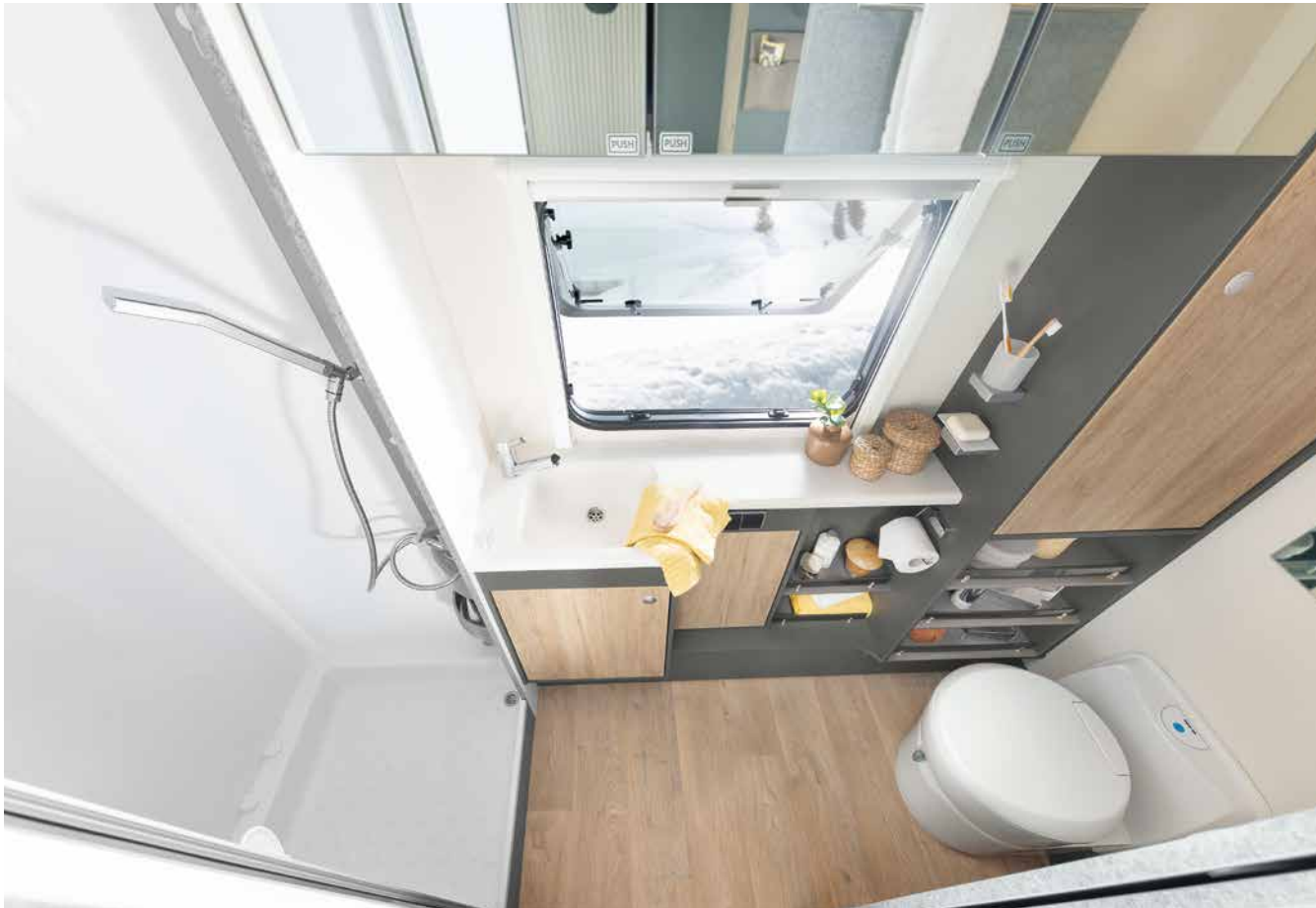

The bathroom, which stretches across the entire width of the vehicle with an integrated shower, is the perfect place to start your day • 690 BQT | Tarragona



Taking a shower? The fold away sink disappears into the wall to save space • 740 BFK | Badalona

COOKING

# Star kitchen for gourmets

All the kitchen you need: apothecary-style drawer, 156-litre fridge including 29-litre freezer with room for everything a foodie's heart could desire • 740 BFK | Amposta



A quick trip to the market. And then cook like a pro chef in the superbly equipped kitchen - with illuminated back wall and full cooker • 650 RE | Amposta



# Beduin Scandinavia Highlights



You can find the full specification for the BEDUIN SCANDINAVIA models in the separate technical information or at [www.dethleffs.com/beduin-scandinavia](http://www.dethleffs.com/beduin-scandinavia)



Large fridge/freezer combination: 137 litres with 15-litre freezer or 156 litres with 29-litre freezer (depending on layout)



Light-flooded front kitchen that stretches across the entire width of the vehicle with full-cooker and large panoramic front skylight (depending on layout)



Seating lounge with sturdy, height-adjustable table (one-hand operation) and high-quality upholstery with corner headrests as standard



AirPlus – perfect air circulation in the interior with rear ventilation of the overhead lockers and sideboards



Spacious rear bathroom across the entire width of the vehicle with plenty of elbow room (depending on layout)

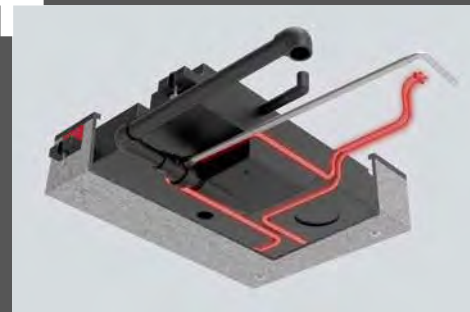

Heated and insulated 42-litre waste-water tank so that nothing freezes – even when the temperature falls below zero (option)



Hot-water heating and electric floor heating as standard



# Variety of choice

---



Amposta



Badalona



Tarragona



Amberes Oak



Further information is provided at:  
[www.dethleffs.com/beduin-scandinavia](http://www.dethleffs.com/beduin-scandinavia)  
or in the separate technical information



Smooth sides, White (standard)

Smooth sides, Silver-Metallic

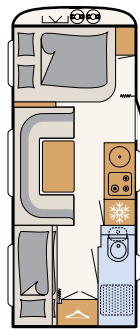

540 QMK

5 sleeping berths

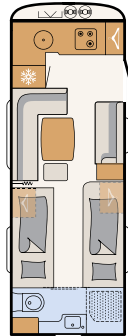

550 BET

3 sleeping berths

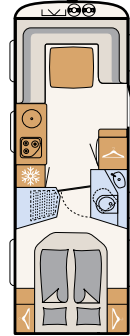

550 RD

3 sleeping berths

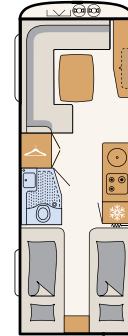

550 SE

3 sleeping berths

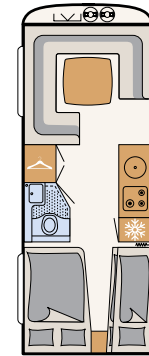

590 RK

6 sleeping berths

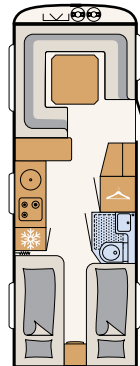

650 RE

4 sleeping berths

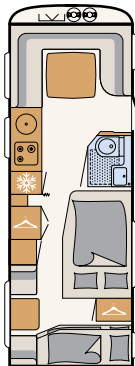

650 RFK

7 sleeping berths

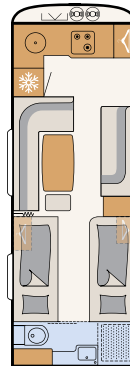

670 BET

3 sleeping berths

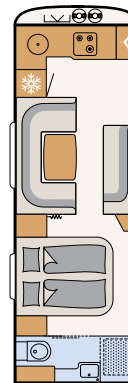

690 BQT

3 sleeping berths

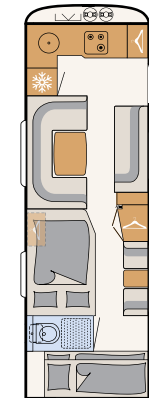

740 BFK

6 sleeping berths

The maximum number of berths is achieved with the converted seating lounge, the three-bunk-beds option as well as some additional options.